

WPF PUZZLE GP 2023 SOLUTION BOOKLET

1. Word Search [Anubhav Balodhi] (34 points)

1

2. Kakuro (Small Snake) [Prasanna Seshadri] (57 points)

2 → 9 3 2 4 2 8 3 1 9

3. Pentominous [Chandrachud Nanduri] (46 points)

4. Star Battle (Myopia) [Chandrachud Nanduri] (15 points)

4

5. Battleships [Chandrachud Nanduri] (29 points)

5

6. Masyu (Canal View) [Prasanna Seshadri] (19 points)

6a →



7. Kakuro [Prasanna Seshadri] (65 points)

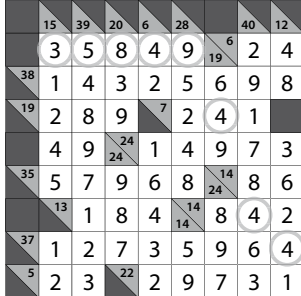

7 → 3 5 8 4 9 4 4 4

8. Snaky Word Search [Anubhav Balodhi] (24 points)

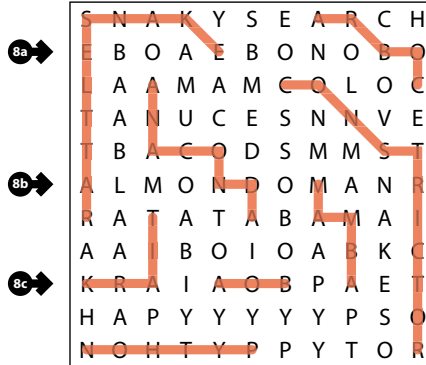

9. Myopia [Madhav Sankaranarayanan] (44 points)

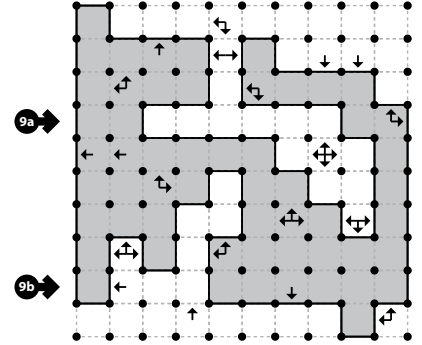

10. Pentominous (Star Battle) [Chandrachud Nanduri] (35 points)

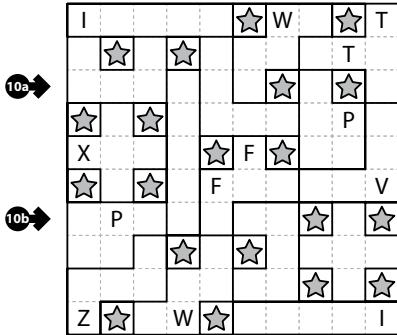

11. Canal View [Chandrachud Nanduri] (26 points)

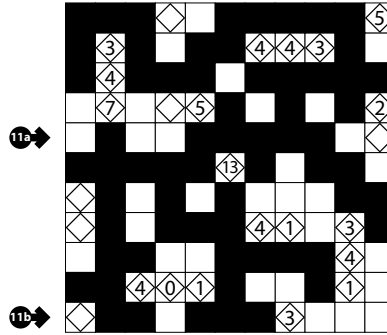

12. Masyu (Battleships) [Madhav Sankaranarayanan] (58 points)

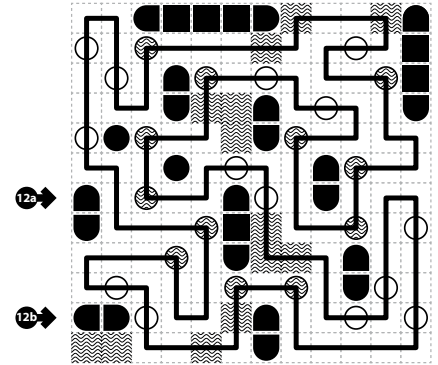

13. Snake [Chandrachud Nanduri] (84 points)

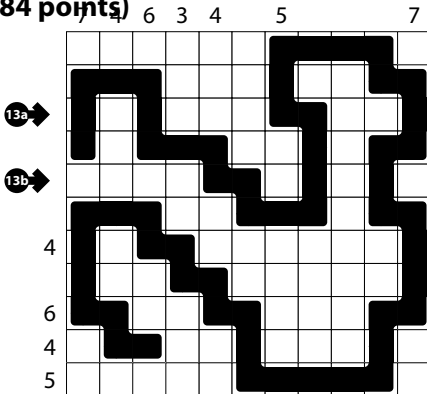

14. Kakuro (Number Search) [Prasanna Seshadri] (52 points)

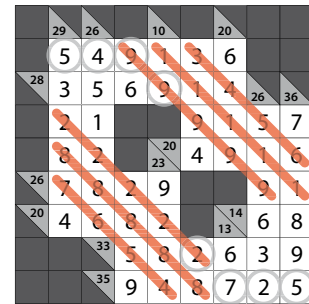

14 → 5 4 9 9 2 7 2 5

15. Star Battle [Rajesh Kumar] (52 points)

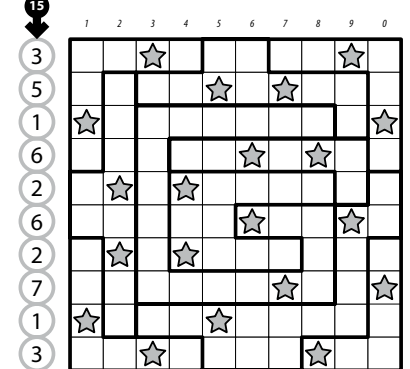

16. Pentominous (Myopia) [Prasanna Seshadri] (66 points)

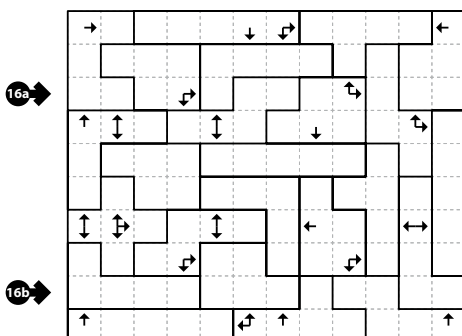

17. Masyu [Rajesh Kumar] (28 points)

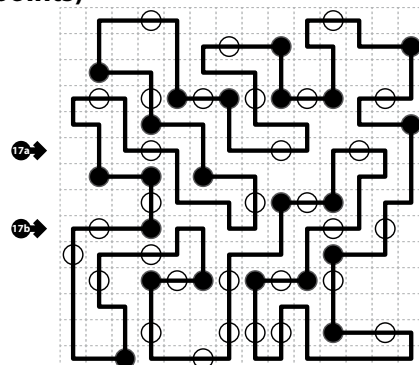

18. Battleships (Canal View) [Anubhav Balodhi] (69 points)

